

Mounting set MH-BT-F10-M12

- Simple mounting
- Conforming to standards
- Adjustable in height
- Adjustable shaft extension

Adjustable assembly set for size F10 manual operated valves according to ISO5211-DIN3337

Function

Assembly set with switch plate for mounting of inductive valve sensors on manual operated valves acc. to ISO5211-DIN3337. The assembly set includes a 2-parts mounting bracket with switch plate, a driver stem and a lock nut.

Dimensions

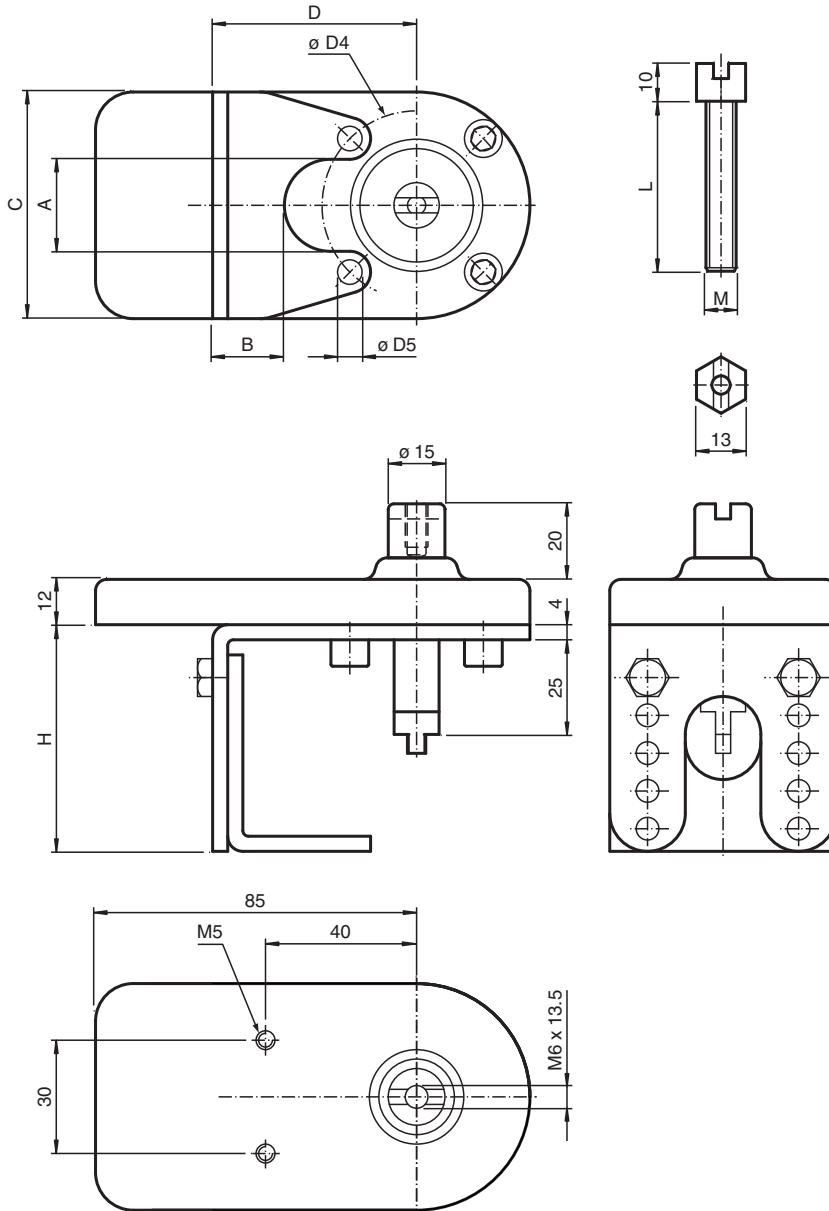

Technical Data

General specifications

Suitable sensors and Double sensor, -F25 series with actuator BT32...
 Double sensor, -F31 series with actuator BT65A
 Double sensor, -F31K series with actuator BT65A

Mechanical specifications

Material Mounting bracket and nut: stainless steel 1.4301
 Tappet and shaft: Stainless steel 1.4305 / AISI 303 (V2A)
 Sensor plate: Vestamid (PA 12), conductive

Dimensions



A	52.12 mm
B	15 mm
C	93 mm
D	74 mm
Ø D4	102 mm
Ø D5	11 mm
H	80 mm / 90 mm / 100 mm / 110 mm / 120 mm , adjustable
L	50 mm

Release date: 2020-06-30 Date of issue: 2020-06-30 Filename: 221947_eng.pdf

Technical Data

M	12 mm
---	-------

Matching system components

	BT32-F25-0	
	BT65A	Activator for F31 series
	BT65X	Activator for F31 series

Release date: 2020-06-30 Date of issue: 2020-06-30 Filename: 221947_eng.pdf

Refer to "General Notes Relating to Pepperl+Fuchs Product Information".

Pepperl+Fuchs Group
www.pepperl-fuchs.com

USA: +1 330 486 0001
fa-info@us.pepperl-fuchs.com

Germany: +49 621 776 1111
fa-info@de.pepperl-fuchs.com

Singapore: +65 6779 9091
fa-info@sg.pepperl-fuchs.com

Mounting

Installation instructions

1. Screw the included locking nut on the attachment. Then screw the attachment into the central tap hole of the manual valve.
2. Assemble the mounting bracket base on the manual valve.

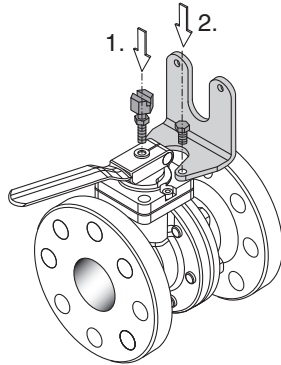

3. Attach the upper part of the mounting bracket with the sensor plate to the previously assembled base. The bore holes allow a rough height adjustment.
4. Fasten the upper part by means of the included screws and the serrated lock washers.
5. Adjust the height of the attachment. The shaft in the upper part has to fit into the groove of the attachment. Fix this position by means of the locking nut.

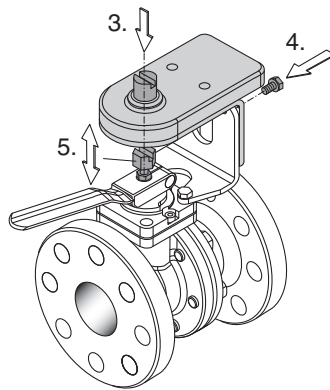

6. Install the actuator (puck) on top of the shaft and the valve sensor on the sensor plate.

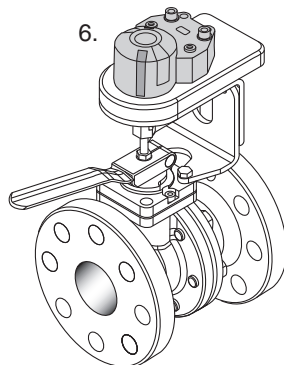

Finally perform a mechanical check of the assembly and a functional check of the position feedback.

Release date: 2020-06-30 Date of issue: 2020-06-30 Filename: 221947_eng.pdf